

AC/DC 350W Enclosed Switching Power Supply

LM350-10Bxx, LM350-10Bxx-C, LM350-10Bxx-Q Series

MORNSUN®



FEATURES

- Selectable AC input range: 90 - 132VAC/180 - 264VAC
- DC input range: 240 - 370VDC
- Ultra low standby power consumption < 0.75W @230VAC
- Operating ambient temperature range: - 30°C to +70°C
- LED indicator for power on
- Output short circuit, over-current, over-voltage, over-temperature protection
- Built-in DC fan
- Operating up to 5000m altitude
- 3 years warranty



LM350-10Bxx series is one of Mornsun's enclosed AC-DC switching power supply. It features selectable AC input and at the same time accepts DC input voltage, cost-effective, low no load power consumption, high efficiency and high reliability. These power supply offer excellent EMC performance and meet IEC/EN61000-4, CISPR32/EN55032, IEC/UL/EN62368, EN60335, GB4943 standards and they are widely used in areas of industrial, LED, street light control, electricity, security, telecommunications, smart home etc.

Selection Guide

Certification	Part No.*	Output Power (W)	Nominal Output Voltage and Current (Vo/Io)	Output Voltage Adjustable Range (V)	Efficiency at 230VAC (%) Typ.	Max. Capacitive Load (µF)
UL/EN/IEC CQC/BIS	LM350-10B05	300	5V/60A	4.5-5.5	83.5	10000
	LM350-10B12	348	12V/29A	10.2-13.8	85	4000
	LM350-10B15	348	15V/23.2A	13.5-18	86	3300
	LM350-10B24	350.4	24V/14.6A	21.6-28.8	87	1500
	LM350-10B36	349.2	36V/9.7A	32.4-39.6	88	1500
	LM350-10B48	350.4	48V/7.3A	43.2-52.8	88.5	470

Note:*Use suffix "C" for terminal with protective cover, suffix "Q" for bottom conformal coating.

Input Specifications

Item	Operating Conditions		Min.	Typ.	Max.	Unit
Input Voltage Range	AC input	Low voltage (switch in position of 115)	90	--	132	VAC
		High voltage (switch in position of 230)	180	--	264	
	DC Input	Switch in position of 230	240	--	370	VDC
Input Voltage Frequency			47	--	63	Hz
Input Current	115VAC		--	6.8	8	A
	230VAC		--	3.4	4	
Inrush Current	Cold start	115VAC	--	60	--	
		230VAC	--	60	--	
Leakage Current	240VAC		--	--	0.75	mA
Hot Plug			Unavailable			

Output Specifications

Item	Operating Conditions		Min.	Typ.	Max.	Unit
Output Voltage Accuracy	Full load range	5V	--	±3	--	%
		12V	--	±1.5	--	
		15V/24V/36V/48V	--	±1	--	
Line Regulation	Rated load		--	±0.5	--	
Load Regulation	0% - 100% load	5V	--	±2	--	

MORNSUN®

MORNSUN Guangzhou Science & Technology Co., Ltd.

2023.05.30-A/9

Page 1 of 5

MORNSUN Guangzhou Science & Technology Co., Ltd. reserves the copyright and right of final interpretation

AC/DC 350W Enclosed Switching Power Supply

LM350-10Bxx, LM350-10Bxx-C, LM350-10Bxx-Q Series

MORNSUN®

		12V	--	±1	--	
		15V/24V/36V/48V	--	±0.5	--	
Output Ripple & Noise*	20MHz bandwidth (peak-to-peak value)	5V/12V/15V/24V	--	150	--	mV
		36V/48V	--	200	--	
Temperature Coefficient			--	±0.02	--	%/°C
Minimum Load			0	--	--	%
Stand-by Power Consumption	230VAC, 25°C		--	--	0.75	W
Hold-up Time	115VAC		--	12	--	ms
	230VAC		--	16	--	
Short Circuit Protection	Recovery time <8s after the short circuit disappear		Hiccup, continuous, self-recover			
Over-current Protection			110% - 180% I _o , self-recover			
Over-voltage Protection	5V		5.75V-6.75V (Hiccup, self-recover)			
	12V		13.8V-16.2V (Hiccup, self-recover)			
	15V		18V-21V (Hiccup, self-recover)			
	24V		28.8V-33.6V (Hiccup, self-recover)			
	36V		41.4V-46.8V (Hiccup, self-recover)			
	48V		55.2V-59.5V (Hiccup, self-recover)			
Over-temperature Protection			Hiccup, self-recover			

Note: *The "Tip and barrel method" is used for ripple and noise test, output parallel 47uF electrolytic capacitor and 0.1uF ceramic capacitor, details please refer to Enclosed Switching Power Supply Application Notes.

General Specifications

Item	Operating Conditions		Min.	Typ.	Max.	Unit	
Isolation Test	Input - ⊕	Electric strength test for 1min., leakage current <3mA	2000	--	--	VAC	
	Input - output	Electric strength test for 1min., leakage current <5mA	3000	--	--		
	Output - ⊕	Electric strength test for 1min., leakage current <3mA	500	--	--		
Insulation Resistance	Input - ⊕	Ambient temperature: 25 ± 5°C	100	--	--	MΩ	
	Input - output	Relative humidity: < 95%RH, no condensation	100	--	--		
	Output - ⊕	Test voltage: 500VDC	100	--	--		
Operating Temperature			-30	--	+70	°C	
Storage Temperature			-40	--	+85		
Fan On/Off Control	Fan On, temperature for Rth3		50	--	--		
	Fan Off, temperature for Rth3		--	--	40		
Operating Humidity	Non-condensing		20	--	90	%RH	
Storage Humidity			10	--	95		
Switching Frequency			--	65	--	kHz	
Power Derating	Operating temperature derating		+50°C to +70°C		2	--	% / °C
	Input voltage derating		90VAC - 100VAC		2	--	
			100VAC - 132VAC		0	--	% / VAC
			180VAC - 264VAC		0	--	
			240VDC - 370VDC		0	--	% / VDC
Safety Standard			IEC/UL62368-1, GB4943.1, IS 13252 (Part 1) safety approved & EN62368-1 (Report) Design refer to EN60950-1, EN60335-1				
Safety Class			CLASS I				
MTBF	MIL-HDBK-217F@25°C		>300,000 h				

Mechanical Specifications

Case Material	Metal (AL1100, SGCC)
Dimensions	215.00 mm x 115.00 mm x 30.00mm
Weight	700g (Typ.)
Cooling Method	Forced air cooling

Electromagnetic Compatibility (EMC)

Emissions	CE	CISPR32/EN55032	CLASS A	
	RE	CISPR32/EN55032	CLASS A	
Immunity	ESD	IEC/EN 61000-4-2	Contact ±6KV/Air ±8KV	perf. Criteria A
	RS	IEC/EN 61000-4-3	10V/m	perf. Criteria A
	EFT	IEC/EN 61000-4-4	±2KV	perf. Criteria A
	Surge	IEC/EN 61000-4-5	line to line ±2KV/line to ground ±4KV	perf. Criteria A
	CS	IEC/EN61000-4-6	10 Vr.m.s	perf. Criteria A
	DIP	IEC/EN61000-4-11	0%,70%	perf. Criteria B

Remark: 1. One magnetic bead should be coupled with the output load line during CE/RE testing.

2. Matching our filter FC-L06WX series, can meet the higher level of EMC.

3. The power supply does not meet the requirements of harmonic current stipulated in EN61000-3-2; This power supply is not suitable for the following situations.

- 1) The terminal equipment is used in the European Union;
- 2) The terminal equipment is connected to public mains supply with 220VAC or greater rated nominal voltage that mandatory to meet the requirements of EN61000-3-2;
- 3) The power supply is installed in terminal equipment with average or continuous input power greater than 75W;
- 4) The power supply belong to a part of lighting system;

In addition, the power supply can be used in the following terminals which do not need to meet EN61000-3-2;

- (1) Professional equipment with total fixed input power greater than 1000W;
- (2) symmetrical controlled heating element with rated power less than or equal to 200W.
4. If no harmonic current is required or customers can solve harmonic current problems by themselves, this product can be used.

Product Characteristic Curve

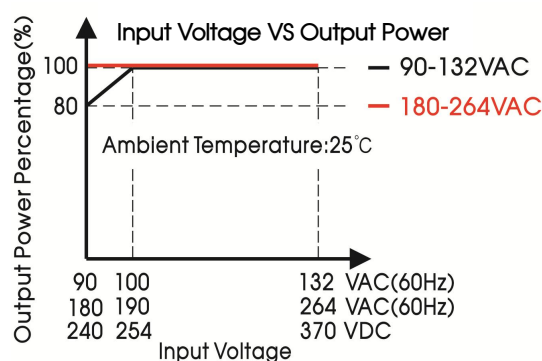
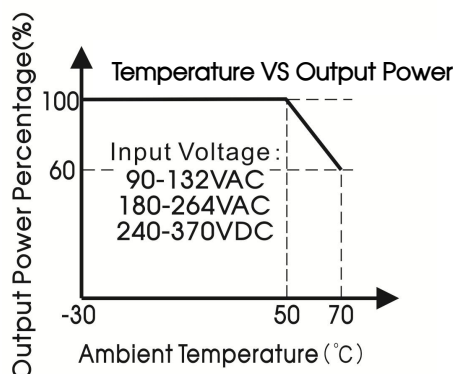

Note: This product is suitable for applications using natural air cooling; for applications in closed environment please consult Mornsun FAE.

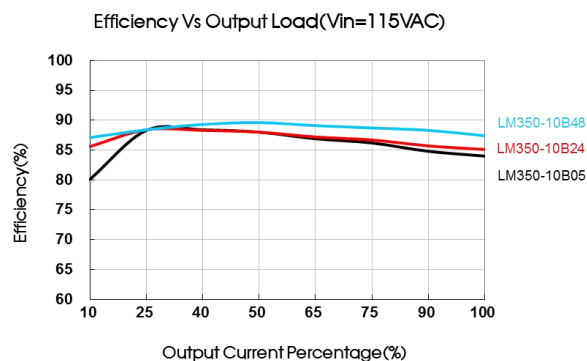
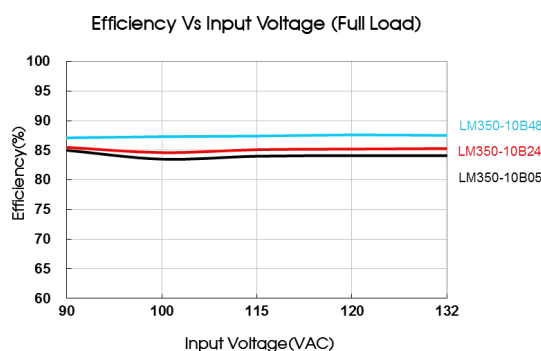

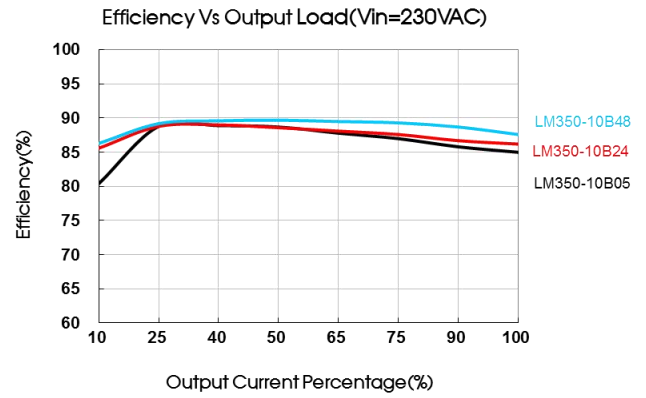
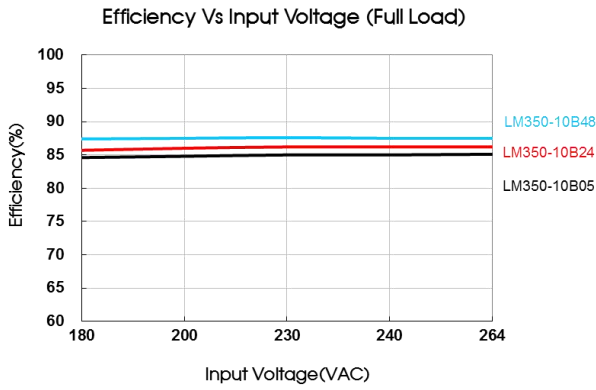

Dimensions and Recommended Layout

LM350-10Bxx, LM350-10Bxx-Q Series

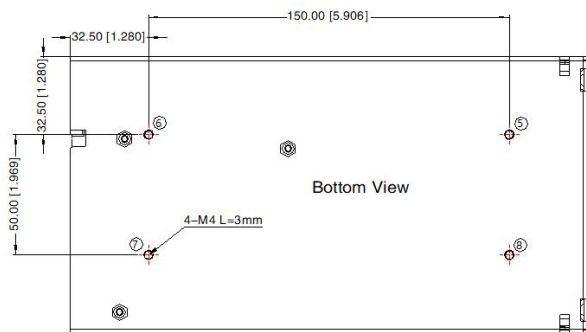
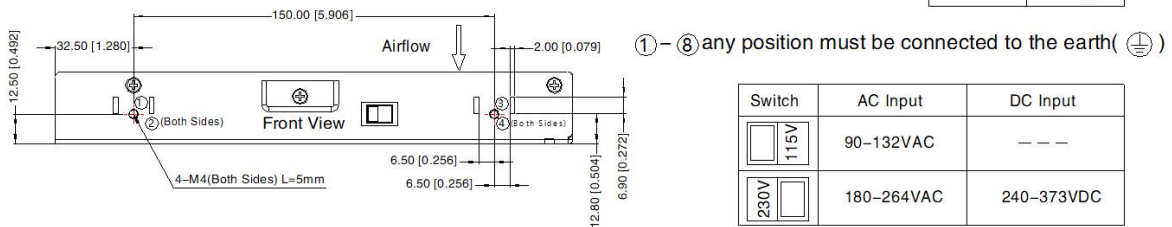
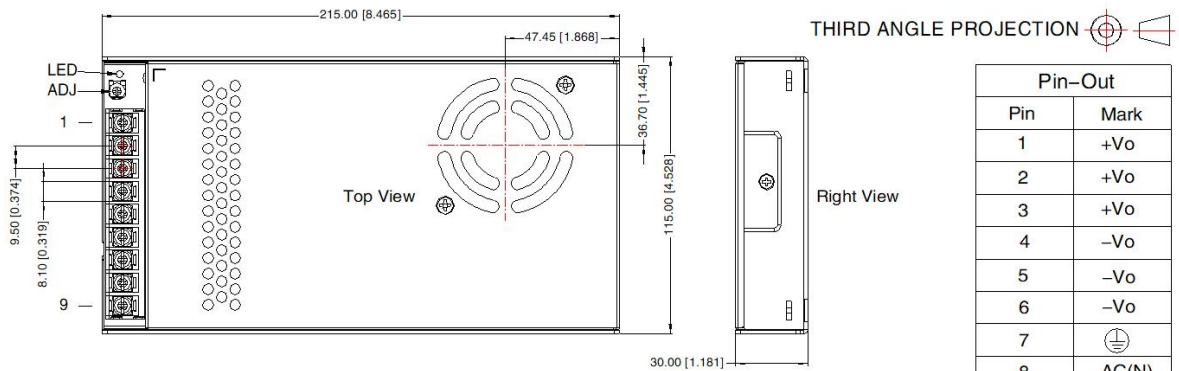

Note:
 Unit: mm[inch]
 ADJ: Output adjustable resistor
 Wire range: 22-12AWG
 Connector tightening torque: M3.5, 0.8N·m
 General tolerances: ± 1.00[± 0.039]

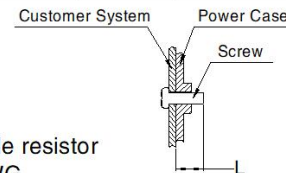

LM350-10Bxx-C Series

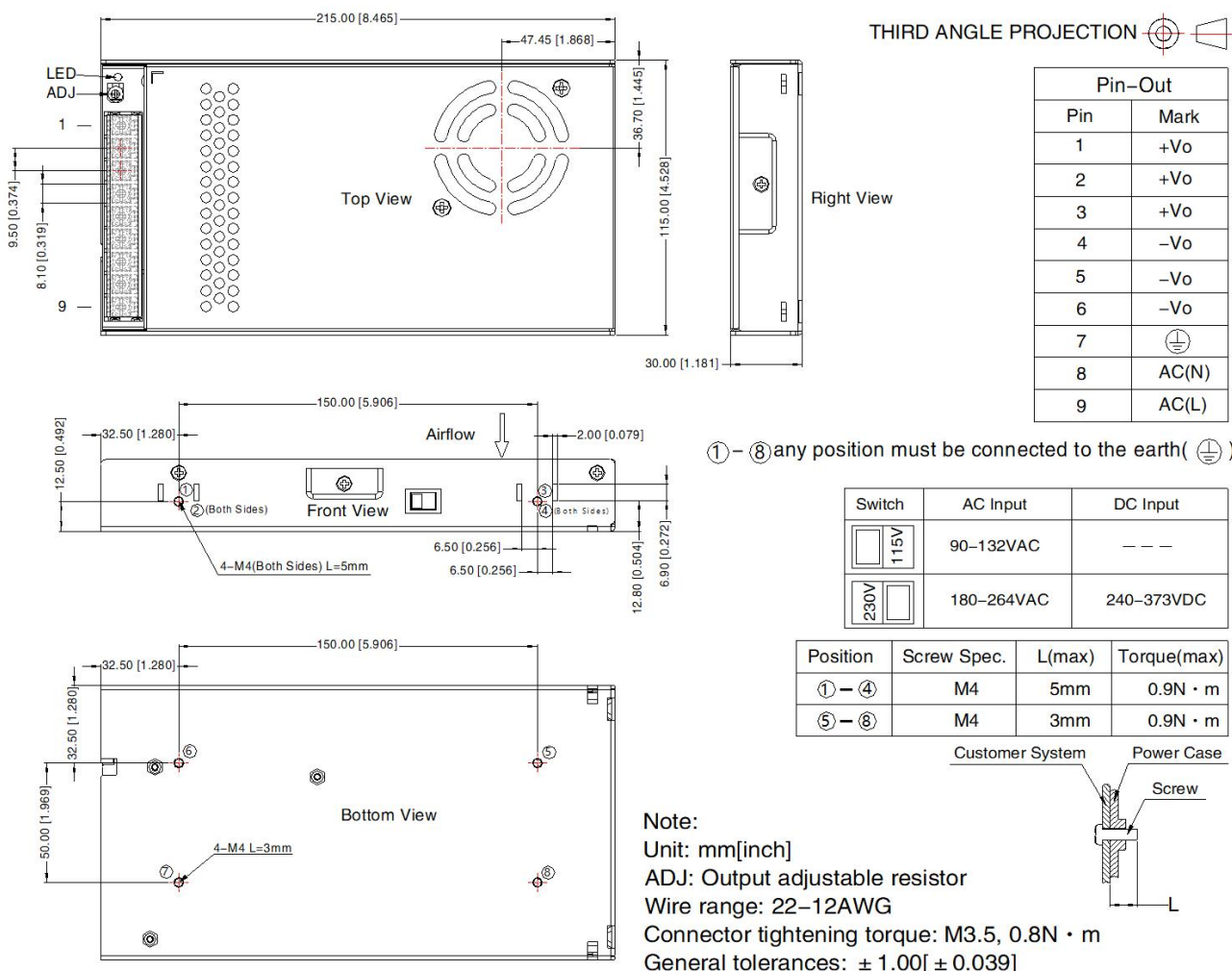

Note:

- For additional information on Product Packaging please refer to www.mornsun-power.com. Packaging bag number: 58220115;
- Unless otherwise specified, parameters in this datasheet were measured under the conditions of $T_a=25^{\circ}\text{C}$, humidity<75%RH with nominal input voltage and rated output load;
- The ambient temperature derating of $5^{\circ}\text{C}/1000\text{m}$ is needed for operating altitude greater than 2000m;
- All index testing methods in this datasheet are based on our company corporate standards;
- In order to improve the efficiency at high input voltage, there will be audible noise generated, but it does not affect product performance and reliability;
- We can provide product customization service, please contact our technicians directly for specific information;
- Products are related to laws and regulations: see "Features" and "EMC";
- The out case needs to be connected to the earth (⊕) of system when the terminal equipment in operating;
- Our products shall be classified according to ISO14001 and related environmental laws and regulations, and shall be handled by qualified units;
- The power supply is considered a component which will be installed into a final equipment. All EMC tests should be confirmed with the final equipment. Please consult our FAE for EMC test operation instructions.

Mornsun Guangzhou Science & Technology Co., Ltd.

Address: No. 5, Kehui St. 1, Kehui Development Center, Science Ave., Guangzhou Science City, Huangpu District, Guangzhou, P. R. China
 Tel: 86-20-38601850 Fax: 86-20-38601272 E-mail: info@mornsun.cn www.mornsun-power.com